



# **BULLETIN**

A bimonthly newsletter for the members and friends of the VCOI

## **CH JNEK'S King of Swing**

DOB 5-14-04



Sire: CH Kedzet's Debonair Reese CDX—OFA Good  
Dam: CH JNEK'S Little Miss Swing Kat JH—OFA Good

CH JNEK's King of Swing *aka* Benny is a BIS BISS CH JNEK'S King Ralph JH ROM grandson. Actually this litter shares their Grandfathers birthday! Benny as a young pup traveled with us to the Garden Specialties which are held at the Meadowlands Complex in New Jersey. These Sporting Specialties are held the weekend before the Westminster Dog Show. Benny competed from the 6-9 puppy classes and won all but one of his classes including puppy sweeps too! This was just a warm up to how this young man would handle himself in the show ring. Benny is a delight in the field too. His running style is effortless and he never misses any birds! A great guy.

## **Show Highlights**

***CWVC Specialty May 2005*** Best of Opposite in Sweeps (his sister Jessie was Best in Sweeps) - Reserve Winners Dog

***VCOI Specialty July 2005*** Winners Dog 5 point major

***Greater Racine Kennel Club August 2005*** Benny finishes his Championship going Winners Dog 3 point major. His sister is Winners Bitch/Best of Winners 4 point major.

## **CH JNEK'S Shooting The Breeze**

OFA Excellent



Sire: BIS BISS CH JNEK'S King Ralph JH ROM—OFA Excellent  
Dam: CH JNEK'S Sweet Charity JH—OFA Excellent

CH JNEK'S Shooting The Breeze *aka* Bria is a Ralph daughter who came out at her first show from the 6-9 month old puppy class and was Winners Bitch and Best of Opposite over Bitch Specials. Bria won her first major win out at the huge Canfield Dog shows in Ohio. This cluster of shows boast of almost 4,000 dogs entered each day! Traveling down to Atlanta, Georgia for the Specialty, Bria was Best In Sweeps. Taking some time off from showing to grow up a bit Bria finishes her Championship at the Christmas Cluster Shows in Wheaton, IL. Bria is very intense on point and loves to hunt. She is all girl!

## **Show Highlights**

***Columbiana County Kennel Club, Ohio*** Best of Winners for a 3 point major

***Kenneshaw Kennel Club, Georgia*** Best Puppy In Sweeps

***Starved Rock Kennel Club, Illinois*** Winners Bitch for a 3 point major to finish Championship

Submitted by Kathy Engelsman JNEK Vizslas  
Breeder/Owner/Handler

**President ~ Began 2005**

Cathy Gallagher  
1405 Surrey Lane  
Algonquin, IL 60102  
847.458.5886  
siennapointe@dls.net

**Vice President ~ Began 2006**

Dennis Nowak  
2820 Brook Ct.  
Joliet, IL 60435  
815.439.0720  
dennisnowak@sbcglobal.net

**Treasurer ~ Began 2006**

Cheryl Lykowski  
516 S. Echo Lane  
Palatine, Illinois 60067  
847.359.3934  
cheryllykowski@comcast.net

**Secretary ~ Began 2006**

Jodi Cieslak  
39W571 S. Hyde Park  
Geneva, IL 60134  
630.232.4297  
jodicieslak@hotmail.com

**2006 Board of Directors**

Rodney Albin ~ Began 2005  
2445 Carter Rd  
Moscow Mills, MO 63362  
636.366.9746  
albinsquailfarm@worldnet.att.net

Pam Spurgeon ~ Began 2005  
5200 Shattuck Rd  
Belvidere, IL 61008  
815.547.9027  
crimsonskyvizslas@t6wireless.com

Jeff Parise ~ Began 2006  
1136 W Fullerton #2  
Chicago, IL 60614  
773.744.1224  
jeffpis@sbcglobal.net

Victor Barger ~ Began 2005  
4880 Highwood Lane  
Lake In The Hills, IL 60156  
847.669.6374  
vcb1024@cs.com

Michel Berner ~ Began 2006  
W342S3976 Moraine Hills Dr  
Dousman, WI 53118  
262.719.6946  
michel@miravizslas.com

Mark Spurgeon ~ Began 2005  
5200 Shattuck Rd  
Belvidere, IL 61008  
815.547.9027  
crimsonskyvizslas@t6wireless.com

**Field Trial Supernumerary**

Greg Hedio  
W89 Circle Drive  
Mundelein, IL 60060  
847.566.6655  
dlcleo@yahoo.com

**Midwest Vizsla Field Futurity Chair**

Rodney Albin  
2445 Carter Rd  
Moscow Mills, MO 63362  
636.366.9746  
albinsquailfarm@att.net

**Webmaster & AKC Education / Program Chair**

Michel Berner  
W342S3976 Moraine Hills Dr  
Dousman, WI 53118  
262.719.6946  
michel@miravizslas.com

**Hunt Test Supernumeraries**

Patty & Dennis Nowak  
2820 Brook Ct.  
Joliet, IL 60435  
815.439.0720  
dennisnowak@sbcglobal.net

**Membership Chair & Directory Developer**

Linda Busch  
2643 Keith Rd.  
Winnebago, IL 61088  
815.335.7673  
lbusch@aeroinc.net

**Volunteer / Database Coordinator & Bulletin Editor**

Jodi Cieslak  
39W571 S. Hyde Park  
Geneva, IL 60134  
630.232.4297  
jodicieslak@hotmail.com

**Specialty Standing Chair**

Kathy Harmer  
7541 Edwardsville Rd  
Rockford, IL 61102  
815.963.3039  
polarkap@aol.com

**Legislative Committee Chair**

Mark Johnson  
2985 Keith Road  
Winnebago, IL 61088  
815.335.2959  
johnson2985@areoinc.net

**Education Committee Chair**

Amy Bowden  
14512 S. Birchdale Drive  
Homer Glen, IL 60491  
708.301.5877  
penquita8@yahoo.com

Opinions expressed in articles are those of the author and do not constitute endorsement by the editorial staff, the VCOI or it's Board of Directors.

The VCOI endorses the efforts of the VCA and the OFA to eliminate hip dysplasia in dogs, and encourages it's members to use only normal breeding stock.

Advertising Rates Per Issue: Half Page \$10.00 Quarter Page \$5.00 Business Card \$2.50 Color ads, any size, will require a price quote before printing

Ads are limited to one half page per family per issue. Editor may limit advertising due to space limitations.

All ads must be paid in full before printing and contain the full OFA rating of the sire and the dam. Copies of the OFA certificate must be sent with the ad.

Deadline for submission to the Bulletin is on the first of each even numbered month. Deadlines are non-negotiable!

Cover stories are limited to one per family membership in a 12 month period. Color covers are available, please ask the editor for a price quote to cover additional printing costs.

All brags, articles, and submissions must be submitted in writing either through the minutes or directly to the Editor.

All photos submitted to the Bulletin must include a Self Addressed Stamped Envelope. Photos without return postage will remain the property of the VCOI. Exception to the cover photo, which will be returned at the VCOI's expense. Digital photos are preferred.

**Bulletin Covers**

May 2006  
~Busch — Daze

July 2006  
~Open

Sept 2006  
~Open

If your dog has completed a prefix title (CH, FC, AFC, CT, MACH etc.) and you want to reserve a cover, contact Jodi at  
jodicieslak@hotmail.com

**Virtual Vizsla**

VCOI Website: www.vizslclubofillinois.org  
Subscribe to the VCOI e-mail list: VCOIinc-subscribe@yahoogroups.com



# The March Field Trial & the MVFF dates are March 10, 11 & 12 Please note the change.

## ***AWARDS BANQUET***

It was exciting to see so many new faces and have 48 members come out and celebrate and honor the various accomplishments VCOI members earned during 2005. Prior to plaques, beautiful picture frames were awarded to all Champions of Records and the names of the dogs earning non-championship titles were read. It was felt by many of our members that the work involved to earn a Junior Hunter, agility or obedience title was work that should not be overlooked, especially for new members training their first dog. The plaque awards were established in order to give equal recognition to all members accomplishing their goals and in the hope to encourage them to move to the next level of competition and continuing learning about their dog, their breed and becoming active in their club. Hopefully, when you see that little empty spot on your plaque it will inspire you to accomplish that goal too! VCOI recognizes the following dogs and owners on their accomplishments (2005 titles in bold):

**FC BERRY'S DIAMOND LK CLEOPATRA SH** (Greg Hedien)  
CH CSILLIG'S DAY OF INFAMY **SH** (Jeff Parise)  
**CH** Crimson's Twenty Gauge Ruger JH, **#1 Derby Dog 2004, 2<sup>nd</sup> Runner Up MVFF 2004** (Pam & Mark Spurgeon)  
**CH** JNEK BET YOUR BOTTOM DOLLAR (Kathy & Mark Martino & Kathy Engelsman)  
CH JNEK'S COMMANDER IN CHIEF **JH** (Kathy, Jeff & Christine Engelsman)  
JNEK'S DONNA'S TAFFY **JH** (Victor & Donna Jagniatkowski & Kathy Engelsman)  
**CH** JNEK'S GUNS N ROSES (Kathy & Mark Martino & Kathy Engelsman)  
CH JNEK'S IT WAS MEANT TO BE **JH** (Jeremy & Jenny Thill and Kathy Engelsman)  
**CH** JNEK'S KING OF SWING, (Kathy, Jeff & Christine Engelsman)  
CH JNEK'S KING RALPH JH, **#1 2004 Top Producer, #2 Vizsla Defeated 2004, #3 All-Breed, 2004** (Jeff, Kathy & Christine Engelsman)  
**CH.** JNEK-KITOME I JES OWN YA NOW, (Kimberly Mozdierz-Frank, Douglas Frank, Kathy Engelsman)  
**CH** JNEK'S LIFE OF RILEY, (Jeremy & Jenny Thill & Kathy Engelsman)  
CH JNEK'S TEACHER'S PET UD, TDX, JH, **NA, NAJ, OA, OAJ, VCD-1, VCD-2** (Mel Lloyd)  
JNEK'S SKYLA STARRY NIGHT **JH** (Kathy Engelsman, Sarah Mullin & Scott Larson)  
JNEK'S ZU-ZU'S PETALS **JH** (Kathy Engelsman, Sarah Mullin & Scott Larson)  
UACHX CH MEHAGIAN'S ZIP-A-DEE-DOO-DAH SH, OA, OAJ, AXP, OJP, CD, VC, **#5 AGILITY EXCELLENT PREFERRED - 2004, #8 OPEN AGILITY PREFERRED - 2004** (Cheryl Peterson)  
CH NORDIC'S HOT DIGITY DAWG JH, NA, NAP, NJP, UAG-2, **NAJ, #2 Novice Agility - 2004** (Cheryl Peterson)  
**FC** ONPOINT RAANY DAZE JH, **#2 Puppy/Derby - 2002** (Jim & Linda Busch)  
CH SUNNYSIDE'S RAINEY DAY BLUES JH NAJ, NA, **OAJ** (Polly Poulos & Jason Waldron)  
SHILOH'S FIRECRACKER JANE, **JH** (Linda Busch)  
**CH** SIENNA POINTE'S KODIAK BEAR JH (Cathy & Larry Gallagher)  
SI CISCO **JH** (Linda Busch & Jonathan Peck)  
**CH** SNOW RIDGE QUINN AGAIN (Susan Boggs)  
TOMAR'S ARTEMIS **JH** (Linda Busch)  
CH VIZION'S GYPSY ROSE **JH** (Linda Busch)  
ZIGFRID'S ZENERGY ZSAR **JH** (Cheryl, Lindsey & Larry Lykowski)  
TRU LOVE OF LIFE **JH** (Dan & Jodi Cieslak)  
- submitted by Cheryl Peterson

## HUMORIST'S DICTIONARY OF DOG SHOW TERMINOLOGY

**ANGULATION** - Degree to which dog handlers will bend over backwards to impress the judges.

**BALANCE** - How to arrange the checkbook so your husband won't know how much money you spent on dog shows last month. Usually done in the bathroom with the door locked.

**BITCH** - A) Name for a lady dog. B) name often overheard at dog shows, not always to describe a lady dog.

**COAT** - The hairy covering of a dog that usually falls out about one week before the Specialty show.

**DAM** - A) A lady dog with children. B) Expression frequently overheard at dog shows as losers leave the ring.

**ELBOW** - Method of getting to ringside when late.

**EXPRESSION** - "Sweet" look adopted by dogs while staring ravenously at chunks of liver.

**FANCIER** - Degree to which some gentlemen handlers dress more than others.

**FEATHERING** - What winners are accused of doing to judges' nests.

**FRONT** - Part of the dog often stacked toward the outside of the ring.

**HEEL** - A) you feel like when your dog beats the one you had just sold to an eager novice. B) Expression often screamed to attract the attention of deaf dogs.

**HEIGHT** - As in "Maximum Allowed", a measurement which all champions fall under by AT LEAST 1/8 of an inch.

**HOOK** - A way of financing your dog shows by the use of jewelry such as wedding rings.

**KENNEL** - Where you go when the kids fight and your husband yells at you.

**LITTER** - Trash left all over the building and parking lot after a dog show.

**MASK** - What to wear when you have to show the pet you sold six months ago.

**MUZZLE** - What to put on your kids at a dog show to prevent them from calling your competition what they overheard you call him last night.

**NOSEPRINTS** - Cute marks left all over your French doors.

**OUTCROSSING** - What your husband tells the minister you are doing out in the kennel with the dog and the bitch.

**POINTS** - Minute, invisible awards for winning which you cannot convince your spouse are more important than cash prizes.

**PUPPIES** - Small, dog like food-processing machines with the ability to stink up an entire house and collectively deafen a band of magpies. (These creatures have not yet been perfected, as they come with a leaky system, and can also be dangerous to weak hearts and bank accounts).



# WEGLER

# VIZSLAS



*is proud to announce an outstanding breeding for 2006 Spring delivery*

### Wegler's Magyar Gypsy Queen JH "Gypsy"

(OFA Good # VZ-7589G26F-PI)

- \* Gun Dog Placements
- \* 3 time Derby Stakes Winner
- \* Puppy and Derby Placements
- \* Junior Hunter Title
- \* Dam to Wegler's Gypsy Garnet JH ( # 7 VCA Puppy/Derby Top 10 -2005 )

### CH Crimson's Twenty Gauge Ruger JH "Ruger"

(OFA Excellent # VZ-8685E24M-PI)

- \* #1 on VCA Puppy/Derby Top 10 list for 2005
- \* Show Champion
- \* Junior Hunter Title
- \* 2<sup>nd</sup> runner up in Midwest Vizsla Field Futurity
- \* Ruger has won in broke Gun Dog stakes & has points toward his FC/AFC
- \* Sired by FC AFC Raany SH who has produced an NVA NFC, VCA NGDC, VCA National Derby Champion, 5 Field Champions, 2 Midwest Field Futurity winners, and numerous VCA Puppy/Derby Top 10 dogs.

Your Puppy

- FA AFC Lifo Riley (OFA-G)
- FC AFC Raany SH (OFA-G)
- My-T-Hi North Starr (OFA-G)
- CH Crimson's Twenty Gauge Ruger (OFA-E)
- FC AFC Buster Keeton MH (OFA-G)
- Madison III SH (OFA-F)
- Allie (OFA-G)

- DC AFC Askim MH HOF (OFA)
- CH Askim Again MH
- JB 'N Squirt JH (OFA-G)
- Wegler's Magyar Gypsy Queen JH
- FC AFC Buster Keeton MH (OFA-G)
- Timarkas Taita (OFA-F)
- Timarka's Toasty (OFA-F)

**Please contact Greg Wegler for details  
815-298-4023 - gypsy2gpw@yahoo.com**

## New Members & Member Updates

I have not had room to put these in the last couple of bulletins so the list is quite large. Some of these are new members, some are renewals and some are just corrections. Please mark your directories for future reference.

If you have an addition or correction to your own information, please let Linda Bush (lbusch@aeroinc.net) and Jodi Cieslak (jodicieslak@hotmail.com) know.

Thanks!

Steven & Danyelle Ayres  
2 Vine Street  
Villa Grove, IL 61956

Ann & Ben Hartley  
2726 12<sup>th</sup> Street,  
Moline, IL 61265  
309-230-1516  
hartleystudio@hotmail.com

Ron Bayly  
Susan Regele  
720 S. Dearborn Street, #PH2  
Chicago, IL 60605-1819  
312-362-1279  
312-343-0672—Cell

Jill Hoffbeck  
9085 215<sup>th</sup> Street West  
Lakeville, MN 55044  
952-469-8493  
612-508-5965—Cell  
jhoffbeck@isd.net  
www.shootingstardogs.com

Jeff Parise  
jeffpis@sbcglobal.net  
773.744.1224

James and Karen Diedrich  
1211 Ranchwood Drive  
Shorewood, IL 60431  
815-729-7424  
jksfg@juno.com

Brian and Kim Hesgard  
6010 W. Hwy M  
Edgerton, WI 53534  
608-741-2418  
khesgard@mhsjvl.org

Mark & Pam Spurgeon  
815-547-9027—Home

Jodi & Dan Cieslak  
630.232.4297—Home

John & Carol Parod  
10860 57<sup>th</sup> Avenue N  
Plymouth, MN 55442  
763-559-0101  
jdparod@rivnet.net

Chad Sprague  
413 South Seymour Street  
PO Box 286  
Oakwood, IL 61858

Jason Waldron  
Polly Poulos  
6601 N. Talman Ave., Apt. 3  
Chicago, IL 60645  
773-764-4187  
vizslamail@earthlink.net

J and Lisa Bristow  
424 S. Washington St.  
Braidwood, IL 60408  
815-458-6651  
landjbristow82@comcast.net

Paul & Kathy Hoogervorst  
303 Meadow Lane  
Lake In The Hills, IL 60156  
847-226-2119—Cell  
pointer9@aol.com

Kathy Martino  
41W540 Rohrsen Road  
Plato Center, IL 60123  
847-464-4947  
630-988-2247— Cell  
asset1228@aol.com

Don & Sue Musil  
17W085 Terry Trail N  
Hinsdale, IL 60521  
630-887-1314  
seaking65@cs.com

Bob Perkins  
5570 Suydam Road  
Leland, IL 60531  
815-378-6253

Joseph & Katherine Fitzsimmons  
5908 N. Neva Street  
Chicago, IL 60631-2443  
773.631.8022  
773.852.7120—Cell  
fitzsmms@yahoo.com

Gerald & Kathleen Aase  
1630 Sleepyhollow  
Dekalb, IL 60115  
815.751.3702  
815.751.3703  
gaase@niu.edu

John & Mary Cernak  
28913 S. Gougar Road  
Manhattan, IL 60442  
815.478.7588

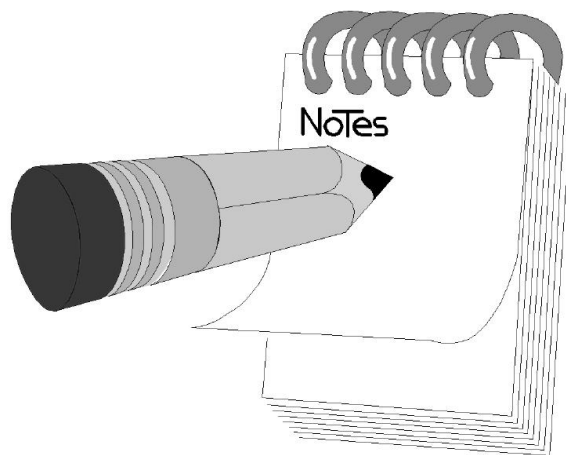

## VCOI Membership Meeting Minutes

01/21/06

### *Marlowe's Restaurant*

The general membership meeting was called to start at 8:20. Lisa Starbuck motions, Brad LePoudre seconds.

The floor was opened up for approval of the minutes from the last meeting. Dennis Nowak motions, Linda Busch seconds

The March Field Trail and MVFF report was given by Jim Busch. He spoke to Rodney Albin who is the MVFF secretary and reported that 38 dogs had been nominated to run and he expected around 80% to be entered. This puts the purse somewhere in the neighborhood of \$2000-\$3000. The winner also receives the Double Lane trophy and second, third and fourth places receive the Single Lane trophy. In past years, the favorite to win the MVFF did not end up as the winner.

The March Field Trial is set to go. There was a mix up on the dates and it should be noted that the corrected dates are March 11 & 12 (with the MVFF being run on Friday the 10th). We have enough senior and junior judges lined up so that there will not be a break in the stakes. This gives us the opportunity to run an additional 10-15 dogs per day. Jim brought a sample of the 3-D crystal trophy that will be awarded to the winners.

The February Hunt Test report was given by Dennis and Patti Nowak. The dates are 02/25 and 02/26 at the Desplaines grounds. The judges are set. Patti noted that they still need some volunteers to come out and help. If you are interested please contact her or Dennis.

The Pet Show report was given by Cathy Gallagher. The show has moved the booths to different locations. We still have a corner for good traffic. The dates for the show are March 17th, 18th and 19th at the Arlington Park racetrack. If you are interested in coming out to volunteer, contact Cathy for more information. We need people to man the booth, to help with set-up and tear down and we also need Vizslas to work the crowd.

The IKC Show club booth report was given by Cathy Gallagher. The dates for IKC are the same weekend as our hunt test, 02/25 and 02/26. We plan on having an informational booth. For more

information or to volunteer, please contact Cathy.

The calendar report was given by Lisa Starbuck. We are getting a lot of compliments on the great pictures in our calendar. Currently we have 144 sold and 75 available for sale. If you are interested (or know anyone who is) please contact Lisa.

Cathy Gallagher thanked both Kevin Berta and Greg Wegler for their time and service to the VCOI. They were presented with a small token of appreciation. Kevin was our VP for 2005 and Greg was on our board.

The Nominating Committee report was given by Linda Busch. She read the list of people nominated for the officer and board positions. She then asked for nominations for the floor - none were stated. Larry Lykowski motioned to approve the slate and Greg Hediend seconded.

Our next two general membership meetings will be held at Jimmy's Charhouse. The times and directions will be listed on the back of the bulletin.

Cheryl Lykowski brought to the floor the location of the 2007 Awards Banquet. A few places were mentioned and Cheryl is going to look into them. If they both have the space and the right menu prices we will do one for 2007 and one for 2008.

We opened up the floor for another other business. It was stated that our June Hunt Test and Training Day is scheduled for June 10th and 11th. Maybe Kim Barker will either secretary or chair. Kathy Engelsman stated that her and Jeff will handle the September Hunt Test.

The Treasurer's Report was given by Cheryl Lykowski. "The Club is solvent". It was stated that the club has brought in \$950 from our online breeder directory. The fall field trail made approximately \$600 in profit and it was donated to the Wanda Berner Fund.

We adjourned the meeting at 8:55pm. Michel Berner made the motion and Linda Busch seconded it.

Respectfully submitted,  
- Jodi Cieslak, VCOI Secretary



**HELP  
WANTED**

# 2006

## FEBRUARY HUNT TEST



**HELP  
WANTED**

**The Vizsla Hunt Test is set for Saturday February 25<sup>th</sup> and Sunday February 26<sup>th</sup>. There are several jobs/positions that need to be filled. In order to run a successful hunt test, we will need several bird planters, line marshals and gunners. Please contact Dennis and Patti Nowak at 815 439-0720 to make arrangements to sign up for your position today!**



## VCOI President's Message *February 2006*

Happy New Year!

Our Annual Banquet and Awards presentation this year at Marlowe's was very well attended and wonderful!!! A huge thank you to Cheryl and Larry Lykowski for the wonderful job they did organizing (mostly Cheryl) and designing the Banquet and Awards Membership Dinner *entertainment* this year! The Jeopardy Game was not only informative but our contestants, Patti Nowak, Greg Hedien, and Brad LePoudre were marvelous and enjoyed their creative prizes!!! Brad already has his string of "amo lights" hung by his hunt gear in his basement!

We have a busy year of events coming up... be sure to check out the website for dates and information about joining the fun! The VCOI Hunt Test is February 25-26<sup>th</sup>, the Field Trial is March 11-12<sup>th</sup>, and we will have a booth at the Chicagoland Family Pet Show, March 17-19<sup>th</sup>! The Family Pet Show is a wonderful event to help the public know more about the Vizsla Breed. It is also a good time to meet other VCOI members and their dogs! Yes!, you can bring your dogs, and we participate in a daily Breed Parade. We have a different booth this year than in years past, but it is a corner booth, so we have lots of room. If you would like to volunteer to work a 2-3 hours shift at the show, please send me an e-mail and let me know if you can attend Friday night (2PM-9PM), Saturday (9AM-9PM) or Sunday (10AM-6PM). [siennapointe@dls.net](mailto:siennapointe@dls.net)

We are also having a booth again this year at the International Dog Show in Chicago at McCormick Place, February 24-27<sup>th</sup>. If you are planning on showing or entering the Blitzen Agility Trial, let me or Jodi Cieslak know, and you can contribute to the Club Display.

Think Spring!!! And remember, it's always about the dogs! ☺

-Cathy Gallagher





2006



# Double Bubble Weekend

July 15 & 16

**All of the fun takes place at the Busch Farm!**

Are you interested in Hunt Tests, Agility, Obedience, Versatility, Conformation or anything else Vizsla related? If so, we need you!

Bring your Vizsla(s), bring your kids and head out to the Busch Farm for a fun filled Double Bubble Weekend!

## Saturday Events

- VCOI Specialty Show & Sweeps (held at Boone County Fairgrounds)
- Lake Superior Tyro Hunting Dog Classic (a mock Hunt Test)
- Membership *FREE* steak dinner!
- Membership Meeting

## Sunday Events

- Locate & Point
- Canine Good Citizen Testing
- Various Seminars on all things Vizsla related
- Raffle Sales
- Wing & String
- Bird Planting Contest
- 2007 Calendar Photo Contest
- Vizsla Merchandise for sale
- and much much more!

**For more information please check out our website**

**[www.vizslclubofillinois.org/doublebubble](http://www.vizslclubofillinois.org/doublebubble)**

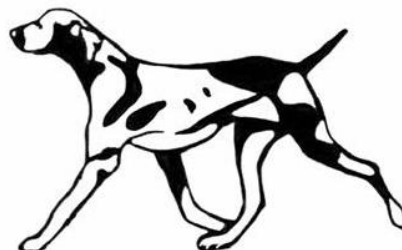





# VCOI BRAGS



**Priden Joy Twilight Victoria** "Vicky" finished her OAJ (open jumpers) title over New Year's weekend at the Great Lakes Belgian Tervuren Club agility trial with a 1st place on 12/31/05 & a 2nd place on 1/1/06. She also finished her RE (rally excellent) title on 1/29/06 at the Paw Power Blues trial with a 4th place. Submitted by Amy Wukotich

**Tru Wild Desire** "Desi" took Reserve from the 12-15 month class handled by Diane Engelking. We are keeping our fingers crossed for IKC! Submitted by Jodi Cieslak

**Strider's Prophet** "Jeremiah" went Reserve to the major from the 6-9 month puppy dog class at the Starved Rock Kennel Club show December 15, 2005. Dam is CH Strider's Seven Of Nine JH, sire is CH Russet Leather Storm Winds SH. Submitted by Michel Berner

## **JNEK Vizsla Brag's**

Gateway Sporting Dog Association:

JNEK Zu-Zu's Petals JH 1st in Open Bitch and Winners Bitch/Best of Winners for a 3 point major at her very first show!

Edwardsville Illinois Kennel Club:

Saturday Dec 3, 2005:

JNEK'S Keep On Dancing 1st in Puppy Class-Reserve Winners Bitch

JNEK-Kitome I Jes Own Ya Now Best in Breed also made the cut in the Sporting Group

JNEK'S Life Of Riley Best of Opposite

Sunday Dec 4, 2005:

JNEK'S Royal Legacy 1st in Puppy Class-Reserve Winners Bitch

JNEK's Skyla Starry Night 1st in Open Bitch and Winners Bitch for 2 points

Christmas Cluster :

Starved Rock Kennel Club:

Wednesday:

JNEK'S Sir Charles Barkley Reserve Winners Dog and Best Puppy

JNEK'S Shooting The Breeze 1st in the Open Bitch class and Reserve Winners Bitch

Thursday:

JNEK'S Sir Charles Barkley 1st in the Bred By Exhibitor Class and Reserve Winners Dog

JNEK'S Keep On Dancing 1st in the Bred By Exhibitor Class and Reserve Winners Bitch

also Best Bred By and Sporting Group 2

**NEW CHAMPION\*** JNEK's Shooting the Breeze earns her last major to finish as a Champion!!?

Fox River Valley Kennel Club:

Friday:

JNEK'S Sir Charles Barkley 1st in his 9-12 puppy dog class Best Puppy and Sporting Puppy Group 1. Looked fantastic in Best In Show

JNEK'S Keep On Dancing 1st in 9-12 puppy bitch class and Reserve winners bitch

CH JNEK'S-Kitome I Jes Own Ya Now Best of Opposite

Saturday:

JNEK'S Sir Charles Barkley 1st in 9-12 class Reserve Winners Dog

JNEK'S Keep On Dancing 1st in 9-12 class and Winners Bitch for a 3 pointt major Jeff handled!

Sweepstakes:

JNEK'S Sir Charles Barkley Best in Sweeps and Sporting Group 3

JNEK'S Keep On Dancing Best of Opposite in Sweeps

## From the desk of the editor.....

Life is certainly busy! I can't find a more accurate description! Looking at the VCOI calendar of events, I see a lot of activity going on in the club. There are lots of good ways to get involved, don't be shy! I hope to see you out supporting the club, the breed and the sport.

Tru and I have taken up running. He gets very excited when he sees the collar and lead come out. By the end of our run when I am ready to crash, he just looks at me wondering when his workout will start! These red devils are so versatile and love to do anything. Desi is not so sure about running in the cold, she would rather stay in the warm house. Makes you wonder who is the smart one LOL!

Dan and I have made the decision to expand our family. No, not another baby, but another red dog. We are on the search for the perfect match... stay tuned for some new puppy tales!

Are you interested in writing? I am looking for some articles to include in the newsletter. If you are interested, let me know.

Cheers!  
- jodi



*"I can't think of anything that brings me closer to tears than when my old dog ~ completely exhausted after a hard day in the field ~ limps away from her nice spot in front of the fire and comes over to where I'm sitting and puts her head in my lap, a paw over my knee, and closes her eyes and goes back to sleep. I don't know what I've done to deserve that kind of friend" ~ Gene Hill*

To January 2007

## Sienna Pointe Vizslas

Breeders of healthy, happy Vizslas with excellent temperaments and talent in agility, conformation, field and obedience!



Cathy & Larry Gallagher  
847.458.5886  
siennapointe@dls.net  
www.siennapointevizslas.com

Paid thru July

## Storm Wind Vizslas



Kirsten Davis  
T 801-602-4538  
F 801-766-5546  
stormwind@swvizslas.com  
www.swvizslas.com

(CH Russet Leather Storm Winds SH)  
Available for Approved Bitches

Qualified Puppies to Approved Homes

# Onpoint Kennels

*Where Field Champions are made*

- Training & Handling for  
AKC Field Trials  
AKC Hunting Tests  
CKC Field Tests  
Personal Gun Dog Training
- Licensed Hunting Preserve
- Bed and Breakfast
- Boarding

John and Debbie Reid  
Onpoint Perm. Reg'd Kennels  
72 Hutchinson Rd. N.  
Mallorytown, ON, CA, KOE 1R0,  
Tel/fax: (613) 659-4888  
info@onpointvizslas.com  
www.onpointvizslas.com

Home of 2x FDSB Champion DC Can. CH Onpoint's Tuff Stuff, FD, TT

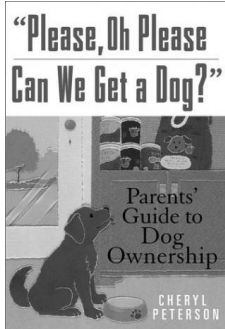

**“Please, Oh Please  
Can We Get a Dog?”**  
Parents' Guide to Dog Ownership  
CHERYL PETERSON

## NORDIC VIZSLAS

**Cheryl Peterson**  
815.338.4760

Know someone looking for a puppy?  
Have them read: *“Please Oh Please,  
Can We Get a Dog? Parents' Guide to  
Dog Ownership”*

**“Do It to Dual It”©**

To January 2007

## Strider & Mira Vizslas

*If it doesn't sport, it doesn't breed*

For more information on stud fees, started dogs, pups and pedigrees

Paid to May 2006



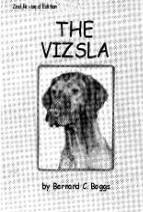

**THE VIZSLA**  
by Bernard C. Boggs

**The Vizsla 2<sup>nd</sup> Revised Edition**  
A major revision to the award-winning breed book by Bernard C. Boggs

**Succeeding with pointing dogs - FIELD TRIALS AND HUNTING TESTS**  
A handbook for training and competing with a pointing dog by B. C. Boggs

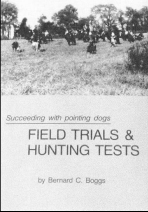

**FIELD TRIALS & HUNTING TESTS**  
by Bernard C. Boggs

\$32.18 includes shipping and Illinois sales tax

**www.vizslabook.com**  
**srvizslas@earthlink.net**  
**Sue Boggs 815-335-3510**

To January 2007

## ALBIN'S QUAIL FARM

Northern Bobwhite Quail  
Year round hatching  
Eggs, Chicks, and Flight Conditioned

**Rodney & Anne Albin**  
2445 Carter Road  
Moscow Mills, MO 63362  
636.366.9746  
albinsquailfarm@att.net

**NPIP Approved**

To January 2007





**Dickerson & Nieman**  
REALTORS

www.dickersonnieman.com  
400 W. Washington  
Oregon, IL 61061

To March 2006

Barbara Ohata  
Realtor  
Office 815-732-3365  
Residence 815-946-9101  
barbarao@dickersonnieman.com



## Vizsla Apparel & Gifts

www.cafeshops.com/MIRADesigns

Featuring a complete line of  
“Life is too short to hunt with an ugly dog” items



AD PAID TO 5/06

The next meeting is...

## Jimmy's Charhouse

2290 Point Blvd., Elgin, IL  
847.783.0200

7:00 pm

See you there!

### Midwest Vizsla Field Futurity

Does your breeding have what it takes?

American Field Registered Event

*"Let's keep them litters nominated!" - Hank Rozanek*

Rodney Albin, Standing Secretary  
Nomination forms and rules available at  
[www.vizslaclubofillinois.org/mvff.htm](http://www.vizslaclubofillinois.org/mvff.htm)



2005 Winner: Diesel  
Owned by Bill Elliott  
Bred by Hank Rozanek

Place  
Postage  
Here

The Vizsla Club of Illinois, Inc.  
Bulletin  
Jodi Cieslak, Editor  
39W571 South Hyde Park  
Geneva, Illinois 60134